

June 8, 1965

G. W. WRIGHT ETAL

3,187,945

MOTORIZED RESET MECHANISM FOR REGISTERS

Filed March 12, 1963

11 Sheets-Sheet 9

FIG. 13

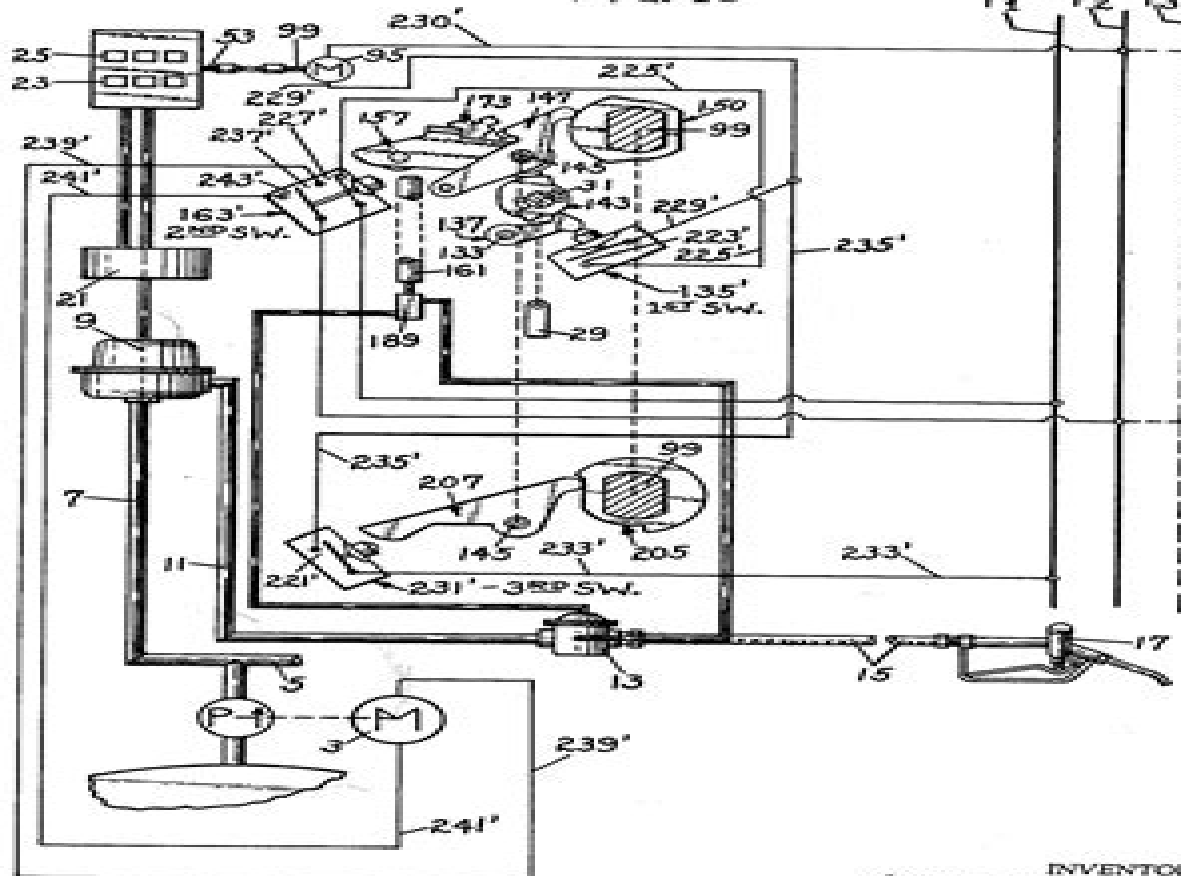

INVENTORS
GEORGE W. WRIGHT,
ELMER A. ROBBINS,
MELVIN C. HANKEL &
BURDETTE W. FOSS
BY: *Conrad R. Lamm*
ATTORNEY

Tokheim 77 Power Reset Manual

J Ma



Tokheim 77 Power Reset Manual:

Ignite the flame of optimism with is motivational masterpiece, **Tokheim 77 Power Reset Manual** . In a downloadable PDF format (PDF Size: *), this ebook is a beacon of encouragement. Download now and let the words propel you towards a brighter, more motivated tomorrow.

https://hersolutiongelbuy.com/book/scholarship/default.aspx/recipe_for_chocolate_covered_coffee_beans.pdf

Table of Contents Tokheim 77 Power Reset Manual

1. Understanding the eBook Tokheim 77 Power Reset Manual
 - The Rise of Digital Reading Tokheim 77 Power Reset Manual
 - Advantages of eBooks Over Traditional Books
2. Identifying Tokheim 77 Power Reset Manual
 - Exploring Different Genres
 - Considering Fiction vs. Non-Fiction
 - Determining Your Reading Goals
3. Choosing the Right eBook Platform
 - Popular eBook Platforms
 - Features to Look for in an Tokheim 77 Power Reset Manual
 - User-Friendly Interface
4. Exploring eBook Recommendations from Tokheim 77 Power Reset Manual
 - Personalized Recommendations
 - Tokheim 77 Power Reset Manual User Reviews and Ratings
 - Tokheim 77 Power Reset Manual and Bestseller Lists
5. Accessing Tokheim 77 Power Reset Manual Free and Paid eBooks
 - Tokheim 77 Power Reset Manual Public Domain eBooks
 - Tokheim 77 Power Reset Manual eBook Subscription Services
 - Tokheim 77 Power Reset Manual Budget-Friendly Options
6. Navigating Tokheim 77 Power Reset Manual eBook Formats

- ePub, PDF, MOBI, and More
 - Tokheim 77 Power Reset Manual Compatibility with Devices
 - Tokheim 77 Power Reset Manual Enhanced eBook Features
7. Enhancing Your Reading Experience
 - Adjustable Fonts and Text Sizes of Tokheim 77 Power Reset Manual
 - Highlighting and Note-Taking Tokheim 77 Power Reset Manual
 - Interactive Elements Tokheim 77 Power Reset Manual
 8. Staying Engaged with Tokheim 77 Power Reset Manual
 - Joining Online Reading Communities
 - Participating in Virtual Book Clubs
 - Following Authors and Publishers Tokheim 77 Power Reset Manual
 9. Balancing eBooks and Physical Books Tokheim 77 Power Reset Manual
 - Benefits of a Digital Library
 - Creating a Diverse Reading Collection Tokheim 77 Power Reset Manual
 10. Overcoming Reading Challenges
 - Dealing with Digital Eye Strain
 - Minimizing Distractions
 - Managing Screen Time
 11. Cultivating a Reading Routine Tokheim 77 Power Reset Manual
 - Setting Reading Goals Tokheim 77 Power Reset Manual
 - Carving Out Dedicated Reading Time
 12. Sourcing Reliable Information of Tokheim 77 Power Reset Manual
 - Fact-Checking eBook Content of Tokheim 77 Power Reset Manual
 - Distinguishing Credible Sources
 13. Promoting Lifelong Learning
 - Utilizing eBooks for Skill Development
 - Exploring Educational eBooks
 14. Embracing eBook Trends
 - Integration of Multimedia Elements
 - Interactive and Gamified eBooks

Tokheim 77 Power Reset Manual Introduction

Tokheim 77 Power Reset Manual Offers over 60,000 free eBooks, including many classics that are in the public domain. Open Library: Provides access to over 1 million free eBooks, including classic literature and contemporary works. Tokheim 77 Power Reset Manual Offers a vast collection of books, some of which are available for free as PDF downloads, particularly older books in the public domain. Tokheim 77 Power Reset Manual : This website hosts a vast collection of scientific articles, books, and textbooks. While it operates in a legal gray area due to copyright issues, its a popular resource for finding various publications. Internet Archive for Tokheim 77 Power Reset Manual : Has an extensive collection of digital content, including books, articles, videos, and more. It has a massive library of free downloadable books. Free-eBooks Tokheim 77 Power Reset Manual Offers a diverse range of free eBooks across various genres. Tokheim 77 Power Reset Manual Focuses mainly on educational books, textbooks, and business books. It offers free PDF downloads for educational purposes. Tokheim 77 Power Reset Manual Provides a large selection of free eBooks in different genres, which are available for download in various formats, including PDF. Finding specific Tokheim 77 Power Reset Manual, especially related to Tokheim 77 Power Reset Manual, might be challenging as theyre often artistic creations rather than practical blueprints. However, you can explore the following steps to search for or create your own Online Searches: Look for websites, forums, or blogs dedicated to Tokheim 77 Power Reset Manual, Sometimes enthusiasts share their designs or concepts in PDF format. Books and Magazines Some Tokheim 77 Power Reset Manual books or magazines might include. Look for these in online stores or libraries. Remember that while Tokheim 77 Power Reset Manual, sharing copyrighted material without permission is not legal. Always ensure youre either creating your own or obtaining them from legitimate sources that allow sharing and downloading. Library Check if your local library offers eBook lending services. Many libraries have digital catalogs where you can borrow Tokheim 77 Power Reset Manual eBooks for free, including popular titles. Online Retailers: Websites like Amazon, Google Books, or Apple Books often sell eBooks. Sometimes, authors or publishers offer promotions or free periods for certain books. Authors Website Occasionally, authors provide excerpts or short stories for free on their websites. While this might not be the Tokheim 77 Power Reset Manual full book , it can give you a taste of the authors writing style. Subscription Services Platforms like Kindle Unlimited or Scribd offer subscription-based access to a wide range of Tokheim 77 Power Reset Manual eBooks, including some popular titles.

FAQs About Tokheim 77 Power Reset Manual Books

How do I know which eBook platform is the best for me? Finding the best eBook platform depends on your reading preferences and device compatibility. Research different platforms, read user reviews, and explore their features before

making a choice. Are free eBooks of good quality? Yes, many reputable platforms offer high-quality free eBooks, including classics and public domain works. However, make sure to verify the source to ensure the eBook credibility. Can I read eBooks without an eReader? Absolutely! Most eBook platforms offer webbased readers or mobile apps that allow you to read eBooks on your computer, tablet, or smartphone. How do I avoid digital eye strain while reading eBooks? To prevent digital eye strain, take regular breaks, adjust the font size and background color, and ensure proper lighting while reading eBooks. What the advantage of interactive eBooks? Interactive eBooks incorporate multimedia elements, quizzes, and activities, enhancing the reader engagement and providing a more immersive learning experience. Tokheim 77 Power Reset Manual is one of the best book in our library for free trial. We provide copy of Tokheim 77 Power Reset Manual in digital format, so the resources that you find are reliable. There are also many Ebooks of related with Tokheim 77 Power Reset Manual. Where to download Tokheim 77 Power Reset Manual online for free? Are you looking for Tokheim 77 Power Reset Manual PDF? This is definitely going to save you time and cash in something you should think about. If you trying to find then search around for online. Without a doubt there are numerous these available and many of them have the freedom. However without doubt you receive whatever you purchase. An alternate way to get ideas is always to check another Tokheim 77 Power Reset Manual. This method for see exactly what may be included and adopt these ideas to your book. This site will almost certainly help you save time and effort, money and stress. If you are looking for free books then you really should consider finding to assist you try this. Several of Tokheim 77 Power Reset Manual are for sale to free while some are payable. If you arent sure if the books you would like to download works with for usage along with your computer, it is possible to download free trials. The free guides make it easy for someone to free access online library for download books to your device. You can get free download on free trial for lots of books categories. Our library is the biggest of these that have literally hundreds of thousands of different products categories represented. You will also see that there are specific sites catered to different product types or categories, brands or niches related with Tokheim 77 Power Reset Manual. So depending on what exactly you are searching, you will be able to choose e books to suit your own need. Need to access completely for Campbell Biology Seventh Edition book? Access Ebook without any digging. And by having access to our ebook online or by storing it on your computer, you have convenient answers with Tokheim 77 Power Reset Manual To get started finding Tokheim 77 Power Reset Manual, you are right to find our website which has a comprehensive collection of books online. Our library is the biggest of these that have literally hundreds of thousands of different products represented. You will also see that there are specific sites catered to different categories or niches related with Tokheim 77 Power Reset Manual So depending on what exactly you are searching, you will be able tochoose ebook to suit your own need. Thank you for reading Tokheim 77 Power Reset Manual. Maybe you have knowledge that, people have search numerous times for their favorite readings like this Tokheim 77 Power Reset Manual, but end up in harmful downloads. Rather than reading a good book with a cup of coffee in the afternoon,

instead they juggled with some harmful bugs inside their laptop. Tokheim 77 Power Reset Manual is available in our book collection an online access to it is set as public so you can download it instantly. Our digital library spans in multiple locations, allowing you to get the most less latency time to download any of our books like this one. Merely said, Tokheim 77 Power Reset Manual is universally compatible with any devices to read.

Find Tokheim 77 Power Reset Manual :

recipe for chocolate covered coffee beans

[recipe for best carbonara](#)

recettes aphrodisiaques pour pimenter lamour

[recipe for chow mein noodle candy](#)

recipe for baked lasagna

[recent historical fiction books](#)

~~recipe easy broccoli cheese soup~~

recipe and brazil nuts

~~recipe for 7 minute icing~~

[recipe for baked lemon pepper chicken](#)

recht op terugkeer het leon de winter

~~recipe for alfredo sauce using cream cheese~~

recipe brewing root beer

recipe by bisquick peach cobbler

recipe baked alfredo bowties

Tokheim 77 Power Reset Manual :

ling bada or mota karne ka nuskha ling ko mota lamba karne - Jun 28 2022

web desi urdu health men june 18 2021 follow ling bada or mota karne ka nuskha ling ko mota lamba karne ka asan tarika ling lamba aur mota karne ka proper ilaj land ko

ling lamba mota bada lund khada karne ke gharelu upay tarike - Sep 12 2023

web 6 6m views 7 years ago ling lamba mota karne ke gharelu upay tarike ayurvedic gharelu nuskhe in hindi mota lund lund lamba karne ka tarika ling bada kare ke upay es

ling ko lamba karna h reply rishabh on june 29 2018 12 31 am aapke lund ko mota karne ke liye apko lund ki malish karna sabse badhiya tarika hai lund ki malish karne

ling lund ko mota lamba bada karne ke upay tarike dawai - Apr 26 2022

web 187 reviews ebook 351 pages 3 79 ebook about this ebook arrow forward ling ko mota lamba bada karne ke upay tarike dawai oil tablet yoga exercise in hindi

lund meaning in hindi lund translation in hindi shabdkosh - Dec 23 2021

web what is lund meaning in hindi the word or phrase lund refers to a city in southern sweden see lund meaning in hindi lund definition translation and meaning of lund

ling mota lamba lamba mota karne ki capsule longjack - Nov 02 2022

web ling mota lamba lamba mota karne ki capsule ke saath ab apne land ko bada mota or lamba bana sakte hai buy best ling mota lamba capsule longjack in with best price

ling ko mota lamba or - Jun 09 2023

web ling ko lamba karne ki vidhi in hindi lund lamba karne tarika - Nov 21 2021

web lund lamba karne tarika the epic of gilgamish feb 25 2021 basic clinical pharmacology nov 24 2020 the most current authoritative and comprehensive

nafs ko lamba karne ka tarika lund nafs ki sakhti facebook - Feb 05 2023

web nafs ko lamba karne ka tarika lund nafs ki sakhti hath zani ling mota timing ka nuskha

lund lamba karne ka nuskha youtube - May 28 2022

web lund lamba karne ka nuskha video link youtu be ptko7dzbkemplund bara karne ka tarika kad bara karne ka tarika in urdu land bara karne ka tarika qad

lund meaning in hindi translation - Feb 22 2022

web lund meaning in hindi get meaning and translation of lund in hindi language with grammar antonyms synonyms and sentence usages by shabdkhoj know answer of

lund - Jul 10 2023

web lund bada karne ke liye purush ko yaniki mard ladke ko apne lund ki dekhbal karne ki jarurat hai male ka lund ko purush ka ling aisa bolte hai lund bada

9 - Aug 11 2023

web important ling lamba mota karne ke liye kya khaye lund mota aour lamba krna hai reply admin says august 18 2019 at 1

40 pm hi apna ling lamba aur mota karne ke
landa ltd - Jan 24 2022

web about us landa ltd is a trading group managing the supply chain for high quality eco friendly and time sensitive lifestyle products we started life in 1987 in hong kong as a

1000mg - Dec 03 2022

web 1000mg 100 rated 4 86 out of 5 based on 7 customer ratings 7 customer reviews 1 299 00

lamba karna meaning in english - Mar 26 2022

web a to lengthen to extend to stretch as to elongate a line v i to depart to or be at a distance esp to recede apparently from the sun as a planet in its orbit a drawn out

[mota lund mota land bada lund ling bada kaise kare hindi](#) - May 08 2023

web try it free mota lund mota land bada lund ling bada kaise kare hindi ling badhane ke upay hindi me lund lamba karne ka tarika ling bada karne ka gharelu tarika in

land ko lamba kaise kare ling bada karne ke desi nuskhe in - Oct 01 2022

web land ko lamba kaise kare ling bada karne ke desi nuskhe in hindi lund lamba karne ka tarika 2018 youtube

[ling bada karne ka upay ling mota lamba kaise kare xlarge](#) - Apr 07 2023

web ling bada karne ka upay 1

lund mota or lamba karne ka nuskha in urdu youtube - Jan 04 2023

web lunmotalun motalun mota or lamba karne ka nuskha hindilun mota karnylund mota or lamba karne ka nuskha in urdulund mota karne ki ayurvedic dawalund mota karn

[ling mota lamba aur](#) - Oct 13 2023

web ling mota lamba aur bada karne ke tareeke jinse savdhaan rehna chahiye in hindi

Aug 31 2022

web

Jul 30 2022

web ling ka size mota lamba or bada karne ka tarika in hindi

igcse biology past papers questions by topic save my exams - Aug 02 2022

web revision notes topic questions past papers

1b igcse biology past papers - Jul 01 2022

web we would like to show you a description here but the site won't allow us

edexcel igcse biology double science past papers - May 31 2022

web past papers concise resources for the igcse edexcel biology double science course exam papers mark schemes new spec jan 2022 qp 1b

edexcel igcse biology past papers study mind - Apr 29 2022

web edexcel igcse biology past papers are previous exam papers that were used in the international general certificate of secondary education igcse biology exam by

past papers cambridge igcse biology 0610 gce guide - Sep 03 2022

web aug 13 2023 past papers cambridge igcse biology 0610 2022 gce guide past papers of cambridge igcse biology 0610 2022 cambridge o levels cambridge

cambridge igcse biology 0610 - Aug 14 2023

web cambridge igcse biology 0610 past papers examiner reports and specimen papers you can download one or more papers for a previous session please note that these

igcse past papers wilsonbiology com - May 11 2023

web past papers from 2005 2019 paper 1 4bi1 1b specimen 2017 ms paper 1 edexcel biology igcse specimen 2017 qp paper 1b edexcel biology igcse paper 2

edexcel igcse biology past papers 4bi1 studydex - Dec 26 2021

web the past papers for the current edexcel igcse biology syllabus can be found here all the available exam past papers are listed below as this is a relatively new syllabus the

cambridge igcse biology past question papers cie vedantu - Jan 27 2022

web sep 7 2023 download free pdf of cambridge igcse biology past question papers on vedantu com for your cambridge international examinations cie register for igcse

mark scheme results summer 2021 pearson qualifications - Oct 04 2022

web jun 4 2021 pearson edexcel international gcse in biology 4bi1 paper 1b and science double award 4sd0 paper 1b edexcel and btec qualifications edexcel and btec

edexcel paper 1 igcse biology past papers pmt physics - Jan 07 2023

web you can find all edexcel biology igcse 4bi0 4bi1 paper 1 past papers and mark schemes below new spec 4bi1 question

[papers january 2020 r qp january 2020](#)

[edexcel igcse biology ig exams - Mar 29 2022](#)

[web paper 1b session year questions papers mark scheme june 2011 here](#)

[edexcel igcse biology past papers tutorchase - Feb 08 2023](#)

[web prepare for your edexcel igcse biology exams with our collection of past papers and mark schemes download now and start practicing for success](#)

mark scheme results january 2018 pearson qualifications - Feb 25 2022

[web mar 8 2018 in biology 4bi0 paper 1b edexcel and btec qualifications edexcel and btec qualifications come from pearson the world s leading learning company we](#)

[mark scheme results january 2019 pearson qualifications - Mar 09 2023](#)

[web mar 7 2019 january 2019 pearson edexcel international gcse in biology 4bi0 paper 1b edexcel and btec qualifications edexcel and btec qualifications are awarded by](#)

past papers past exam papers pearson qualifications - Jun 12 2023

[web our easy to use past paper search gives you instant access to a large library of past exam papers and mark schemes they re available free to teachers and students although](#)

[edexcel igcse biology past papers save my exams - Jul 13 2023](#)

[web june 2022 paper 1b qp june 2022 paper 1b ms june 2022 paper 1br qp june 2022 paper 1br ms june 2022 paper 2b qp june 2022 paper 2b ms june 2022](#)

[edexcel igcse biology past papers 4bi0 studydex - Oct 24 2021](#)

[web the past papers for the old edexcel igcse biology syllabus can be found here all the available exam past papers are listed below you can download or view the igcse](#)

pearson edexcel international gcse biology save my exams - Nov 05 2022

[web paper reference biology unit 4bi0 science double award 4sc0 paper 1b tuesday 9 january 2018 afternoon time 2 hours you must have ruler calculator instructions](#)

past papers cambridge igcse biology 0610 gce guide - Apr 10 2023

[web aug 13 2023 cambridge igcse biology 0610 cambridge igcse biology 0610 past papers cambridge igcse biology 0610 question papers cambridge igcse](#)

webb discovers methane carbon dioxide in atmosphere of k2 - Sep 22 2021

[web sep 11 2023 a new investigation with nasa s james webb space telescope into k2 18 b an exoplanet 8 6 times as massive as earth has revealed the presence of carbon](#)

[past papers cambridge igcse biology 0610 gce guide - Dec 06 2022](#)

[web aug 13 2023 past papers cambridge igcse biology 0610 2014 gce guide past papers of cambridge igcse biology 0610 2014 cambridge o levels cambridge](#)

[updated igcse past year papers 2023 topical past - Aug 22 2021](#)

[web topical past papers biology updated igcse past year exam papers 2023 with marking scheme and specimen papers up to 2025 subject available english physics](#)

[biology ig exams - Nov 24 2021](#)

[web paper 1 paper 1 session year variant questions papers mark scheme model answer october november 2001 1 here here here may june 2002 1 here here here october](#)

[savita bhabhi indian porn comics all free episodes in pdf - Apr 02 2023](#)

[web mar 29 2008 all free episodes read and download all free episodes of the savita bhabhi cartoon and xxx apartments comics in pdf and try yourself out if the savita bhabhi membership is worth it if you like our free cartoons you can visit our subscribe page for more comics](#)

[savita bhabhi english fsicomics - Sep 26 2022](#)

[web read all episodes of savita bhabhi english comics episodes for free at fsicomics read now the latest indian savita bhabhi adult comic in english savita bhabhi is a regular indian woman in the eyes of the world but only a few lucky people know who she really is she is a woman who finds the need to explore her sexuality and enjoy the moment](#)

[savita bhabhi episode 75 the father s daughter in law s - Jun 23 2022](#)

[web savita bhabhi episode 75 the father s daughter in law s latest chapters free to read](#)

[savita bhabhi all 83 episodes archive org - Aug 06 2023](#)

[web jun 7 2023 2008 topics pornographic cartoon pdf collection opensource language english savita bhabhi is a pornographic cartoon character a housewife published by kirtu her promiscuous behaviour is justified by ashok her husband the title bhabhi sister in law is a respectful term for north indian housewives](#)

[savita bhabhi free download borrow and streaming internet - Sep 07 2023](#)

[web may 28 2022 opensource language english savita bhabhi is the first indian porn comics star who is popular since 2009 she keeps you turned on while she enjoys every moment of her sexual adventures addeddate 2022 05 28 18 36 04 identifier savitabhabi identifier ark ark 13960 s24psjv3rq6 ocr tesseract 5 0 0 1 g862e ocr detected lang en](#)

[savita bhabhi all episodes free download pdf video pornogids - Mar 21 2022](#)

[web we hasten to please you you don t have to search for no need to search all over the internet for the desired video below are the best xxx videos with savita bhabhi all episodes free download pdf in high quality exclusively on our website you can](#)

see real fuck where the plot has savita bhabhi all episodes free download pdf

[savita bhabhi episode 112 a new life pdf mo8jl4p73v2n](#) - Oct 08 2023

web download view savita bhabhi episode 112 a new life pdf as pdf for free more details pages 141 preview full text loading documents preview related documents more documents from rprafal savita bhabhi episode 112 a new life pdf mo8jl4p73v2n

download savita bhabhi free pdf oiipdf com - Nov 28 2022

web download savita bhabhi pdf title savita bhabhi category adult comic language english region india tags adult comics sex comics savita bhabhi comics savita bhabhi indian porn comics format

download savita bhabhi episode 112 a new life pdf - Mar 01 2023

web download savita bhabhi episode 112 a new life pdf type pdf date march 2021 size 12 6mb author ghi98183 this

document was uploaded by user and they confirmed that they have the permission to share it if you are author or own the copyright of this book please report to us by using this dmca report dmca

[download top 269 savita bhabhi books pdf pdfdrive](#) - May 03 2023

web top 269 savita bhabhi books pdf download free on pdfdrive try now

savita bhabhi all episode pdf s for free download kevera - Dec 30 2022

web below you can read and download the free episodes of savita bhabhi comics in pdf and try yourself out if the savita bhabhi membership is worth it if you d like to read more indian porn comics please visit loving and innocent south indian aunty velamma

savita bhabhi episode 41 village festival comicless - Oct 28 2022

web savita bhabhi episode 41 village festival adult comics savita bhabhi episode 41 village festival 5 2493 43 author spiesger type porn subscribe read now click

[savita bhabhi archive org](#) - Apr 21 2022

web bhabhi i think i m gonna cum just by licking your pussy you can eat bhabhi s cunt forever and ever beta i don t think can hold it any longer too beta ooooff i don t think i can stay anymore too madam your dick is really digging and exploring my whole pussy i wanted to get a taste of your sweet cunt bhabhi hahal it can t get enough of your

savita bhabhi indian porn comics official site - Aug 26 2022

web mar 24 2023 savitabhabhi vip is the official home of your favorite porn comics of savita bhabhi or xxx apartments read indian sex cartoon in english hindi previously at kirtu com

savita bhabhi savita bhabhi ep 25 the uncle z lib org - Jul 25 2022

web savita darling after that day uncleji would find new ways to tease savita he wouldn t leave her alone even when ashok was in the house sorry uncle i thought savita was in here a 1 just came for some water qkirtu com

[savita bhabhi episode 58 93 download pdf magazines](#) - Jun 04 2023

web apr 21 2020 savita bhabhi episode 58 93 english 34 issues pdf zip 774 3 mb no 91 and 92 issues part 1 savita bhabhi 157

savita bhabhi 8muses sex and porn comics - Jul 05 2023

web savita bhabhi episode 1 bra salesman savita bhabhi episode 2 the crickett savita bhabhi episode 3 the party savita bhabhi episode 4 visiting cousin savita bhabhi episode 5 servant boy savita bhabhi episode 6 virginity lost savita bhabhi episode 7 doctor doctor savita bhabhi episode 8 the interview













savita bhabhi episode 100 k2kz9n0emg2y vbook pub - Jan 31 2023

web overview download view savita bhabhi episode 100 as pdf for free more details words 861 pages 123 preview full text loading documents preview related documents savita bhabhi episode 100 k2kz9n0emg2y 95397 5cb6f35578d6f95397 5cb6f35578d6f page 1 2019 savitabhabhi com

savita bhabhi free mobile porn xxx sex videos and porno - Feb 17 2022

web savita bhabhi indian wife ek vehshia runtime 2 min tap to preview download rating 2 8 s1 e1 savita bhabhi fucked her tenant in kitchen room runtime 7 28 touch to watch download rating 3 9 erotic desi bhabhi part 3 runtime 15 min tap to preview download rating 3

savita bhabhi episode 17       **2** - May 23 2022

web apr 20 2023 indian comics pdf savita bhabhi episode 17       2 report broken       2 chapter high quality sub indo savita bhabhi sexy adult indian comics free april 20 2023